

LOC	DIST	REVISIONS					
CM	00	P	LTB	DESCRIPTION	DATE	DWN	APVD
		P		REVISED PER ECO-11-005027	18MAR2011	RK	HMR

- ① HOUSING MATERIAL: POLYCARBONATE UL 94 V-0
- ② CONTACT MATERIAL: COPPER
PLATING: SILVER
- ③ 647893-4 (COLOR GRAY) AND 647893-7 (COLOR BLACK)
KEY DETAIL ARE SHOWN.
- 4. A KIT INCLUDES 1 HOUSING SPRING ASSEMBLY AND 2 CONTACTS.
- 5. THIS PRODUCT HAS PASSED VERIFICATION AND AGENCY APPROVALS TESTING AND IS COMPONENT RECOGNIZED PER UL 1977 AND CSA 22.2. TE CONNECTIVITY PRODUCT QUALIFICATION TESTING IS NOT YET COMPLETE.

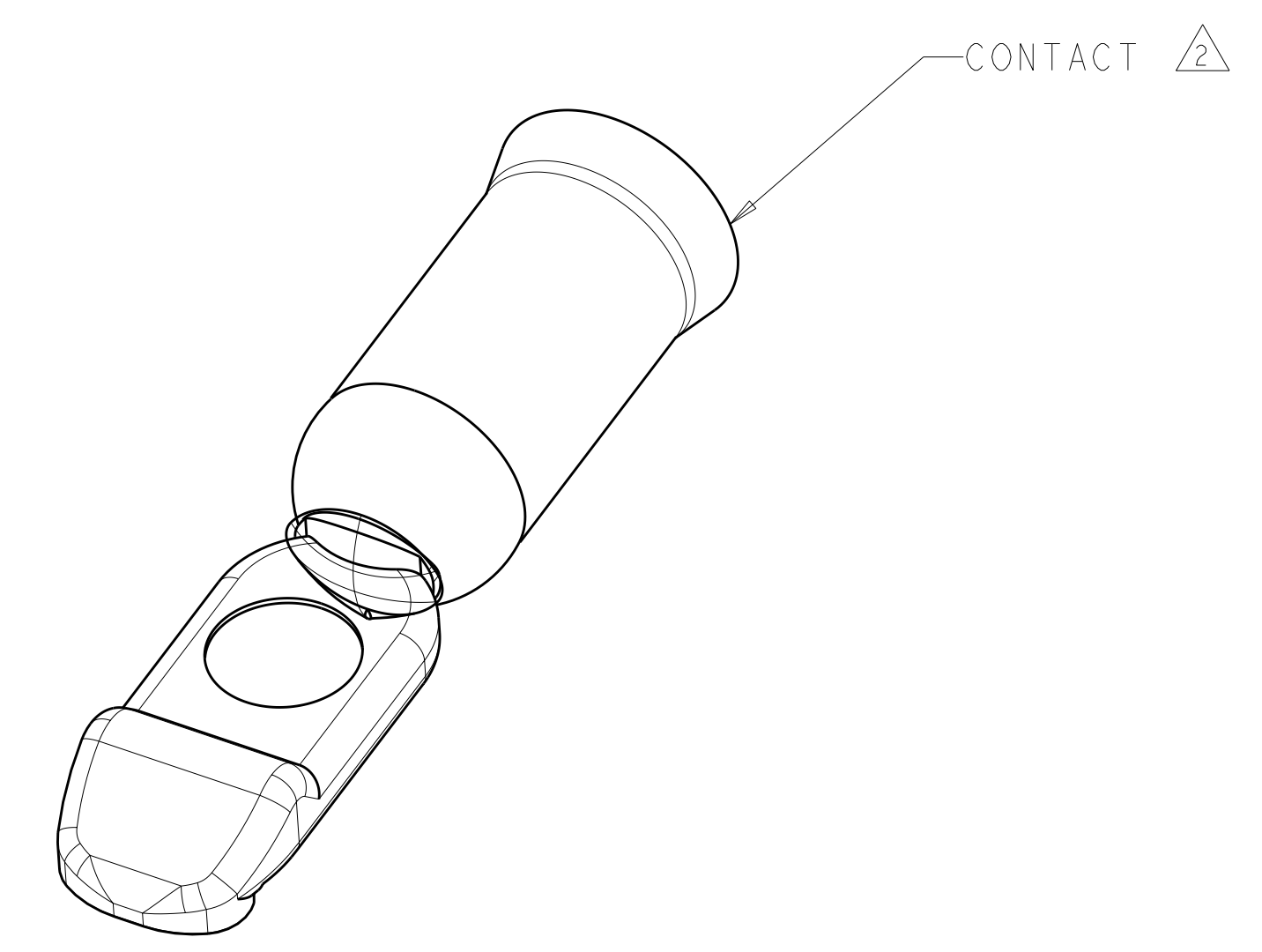
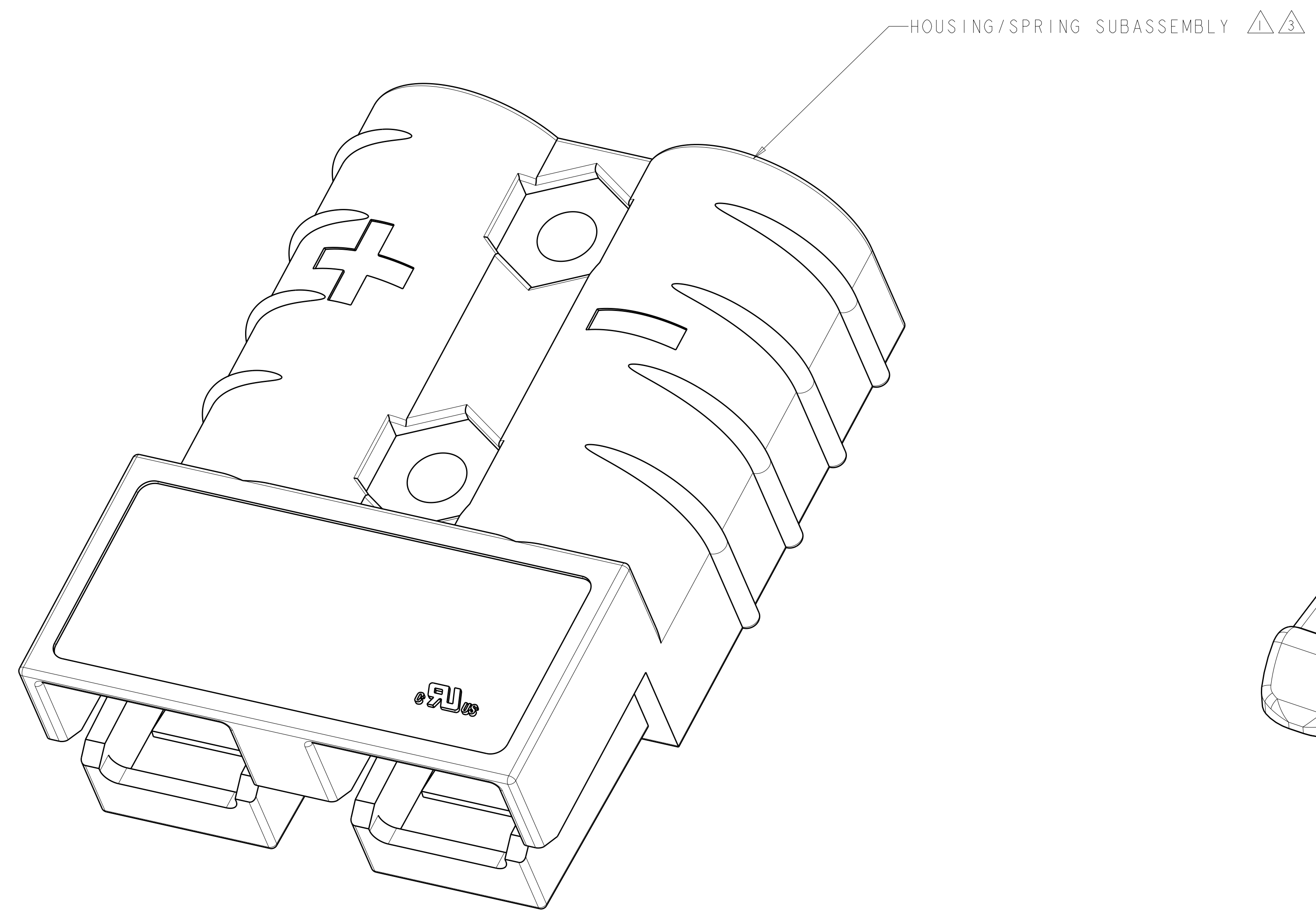

647879-1	647845-8 (YELLOW)	647893-8
647879-1	647845-7 (BLACK)	647893-7
647879-1	647845-5 (BLUE)	647893-5
647879-1	647845-4 (GRAY)	647893-4
647879-1	647845-3 (RED)	647893-3
② CONTACT	① HOUSING/SPRING SUBASSEMBLY	KIT P/N

THIS DRAWING IS A CONTROLLED DOCUMENT.		DWN SHANE WIESE 15JUN2001	TE Connectivity
DIMENSIONS: mm		CHK K. KETELSLEGER 15JUN2001	
TOLERANCES UNLESS OTHERWISE SPECIFIED:		APVD K. KETELSLEGER 15JUN2001	NAME CONNECTOR KIT, AMP POWER SERIES 50, 10-12 AWG
0 PLC ± 1 PLC ± 2 PLC ± 3 PLC ± 4 PLC ± ANGLES ±		PRODUCT SPEC	SIZE CAGE CODE DRAWING NO
MATERIAL FINISH		APPLICATION SPEC	RESTRICTED TO
		WEIGHT	A1100779C=647893
		CUSTOMER DRAWING	SCALE 5:1 SHEET 1 OF 1 REV P